

Fitting name:
MSL_Bay X_9mm Xicato
XIM_98CRI_3000K_700lm_Narrow

Date:
05/10/2017

Delivered Output: **539 Lumen**

LOR: **77% ***

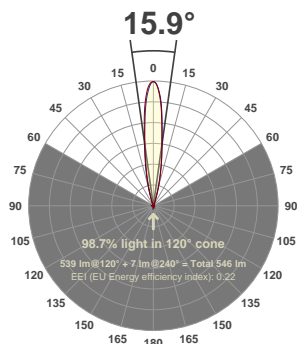

Beam details

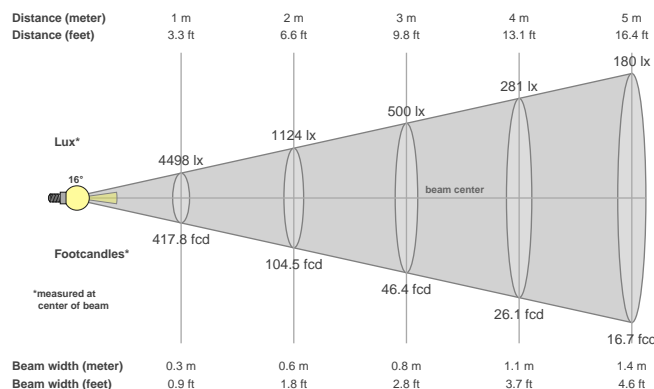

Beam angles

Beam angle 50%	Field angle 10%	Cutoff angle 2,5%
15.9°	32.9°	45.5°

Beam intensities

Peak intensity	Int. ratio in 120° cone	Int. ratio in 90° cone
4501 cd	98.7%	96.8%

Beam intensities from 1-20m

1m	2m	3m	4m	5m	6m	7m	8m	9m	10m	11m	12m	13m	14m	15m	16m	17m	18m	19m	20m
3.3ft	6.6ft	9.8ft	13.1ft	16.4ft	19.7ft	23ft	26.2ft	29.5ft	32.8ft	36.1ft	39.4ft	42.7ft	45.9ft	49.2ft	52.5ft	55.8ft	59.1ft	62.3ft	65.6ft
4498lx	1124lx	500lx	281lx	180lx	125lx	92lx	70lx	56lx	45lx	37lx	31lx	27lx	23lx	20lx	18lx	16lx	14lx	12lx	11lx
417.8fcd	104.5fcd	46.4fcd	26.1fcd	16.7fcd	11.6fcd	8.5fcd	6.5fcd	5.2fcd	4.2fcd	3.5fcd	2.9fcd	2.5fcd	2.1fcd	1.9fcd	1.6fcd	1.4fcd	1.3fcd	1.2fcd	1fcd

Files are generated using the highest CRI and highest output 3000K light source available in the luminaire, other lower outputs and colour temperatures are of course available. Other outputs and colour temperatures are available on request, these may take some time as they must be tested.

* These files are absolute measurements, not relative, as such the LOR is not generated when testing a fitting. To get an idea of LOR please use the measured delivered output in the files and documentation and calculate a ratio using the light source output mentioned in the file and product names. Note that the source output files will be nominal figures provided to us by the light source manufacturers and assuming a max 35°C ambient temperature so this LOR is as stated an indication only. Eventually we will have manually calculated these numbers and entered them into all the files.

The power figures in the files have been generated based on the voltage and current to the light source only, not allowing for any driver losses. This is because our fittings are used with a number of different drivers (sometimes integral) and loaded differently, these variations effect the driver power factor and efficiency which in turn skews the power consumption figure.

Files are not always available for the specific combination of beam, accessory, driver selected, so these can be specifically requested. As with requests for specific colour temperatures this can take some time to generate as these combinations must be made then scheduled in to testing. MSL will advise on how long requests for specific data are likely to take.

MSL advise that lighting designers apply a +/- 5% tolerance allowance on the files we provide as subtle variations in system components (eg slight variations in output of LED light sources through a bin) and ambient temperature variations can effect output and distribution slightly.

Glare Evaluation According to UGR

p Ceiling	70	70	50	50	30	70	70	50	50	30	
p Walls	50	30	50	30	30	50	30	50	30	30	
p Floor	20	20	20	20	20	20	20	20	20	20	
Room size X Y	Viewing direction at right angles to lamp axis					Viewing direction parallel to lamp axis					
2H	2H	11.5	12.2	11.8	12.4	12.6	11.8	12.4	12.0	12.6	12.8
	3H	11.4	12.0	11.7	12.2	12.5	11.6	12.2	11.9	12.5	12.7
	4H	11.3	11.9	11.6	12.1	12.4	11.6	12.1	11.9	12.4	12.6
	6H	11.2	11.8	11.6	12.0	12.3	11.5	12.0	11.8	12.3	12.6
	8H	11.2	11.7	11.5	12.0	12.3	11.5	12.0	11.8	12.2	12.5
	12H	11.2	11.6	11.5	11.9	12.3	11.4	11.9	11.8	12.2	12.5
4H	2H	11.4	11.9	11.7	12.2	12.4	11.6	12.2	11.9	12.4	12.7
	3H	11.2	11.7	11.6	12.0	12.3	11.5	11.9	11.8	12.2	12.5
	4H	11.1	11.5	11.5	11.9	12.2	11.4	11.8	11.8	12.1	12.5
	6H	11.1	11.4	11.5	11.8	12.1	11.3	11.6	11.7	12.0	12.4
	8H	11.0	11.3	11.4	11.7	12.1	11.3	11.6	11.7	11.9	12.3
	12H	11.0	11.2	11.4	11.6	12.1	11.2	11.5	11.7	11.9	12.3
8H	4H	11.0	11.3	11.4	11.7	12.1	11.3	11.6	11.7	11.9	12.3
	6H	10.9	11.2	11.4	11.6	12.0	11.2	11.4	11.6	11.8	12.3
	8H	10.9	11.1	11.4	11.5	12.0	11.1	11.3	11.6	11.8	12.2
	12H	10.8	11.0	11.3	11.4	11.9	11.1	11.2	11.6	11.7	12.2
12H	4H	11.0	11.2	11.4	11.6	12.1	11.2	11.5	11.7	11.9	12.3
	6H	10.9	11.1	11.4	11.5	12.0	11.1	11.3	11.6	11.8	12.2
	8H	10.8	11.0	11.3	11.4	11.9	11.1	11.2	11.6	11.7	12.2
Variation of the observer position for the luminaire distance S											
S = 1.0H	+2.1 / -5.7					+1.9 / -5.8					
S = 1.5H	+4.5 / -96.1					+4.2 / -96.4					
S = 2.0H	+6.4 / -94.1					+6.2 / -94.4					
Standard table	BK00					BK00					
Correction summand	-7.2					-6.9					
Corrected glare indices referring to 539lm total luminous flux											

UGR data could be incorrect as lamp output is not symmetrical. Goto Edit->Photometric->Corrections and select Correct asymmetry.